

Horizontal vægbeslag L510 mm



Anvendelse

Anvendes stort set i alle industrier, kontorbyggeri, uddannelsesinstitutioner, hospitaler etc. Samler kabler, ledninger samt rør og holder styr på ledningsføringen. Herved sikres kabler og ledninger for unødvendig slitage og vedholder performance.

Varenr.: 614050

Specifikation

Materiale: Rustfrit stål pregalvaniseret
Størrelse: L510xB40xH150mm
Tykkelse: 1,5 mm
Diameter (monterings huller): Ø8,5x20mm

Monteringsplade

Størrelse: H150xB45 mm
Tykkelse: 4,0mm
Diameter (monterings huller): Ø11x25mm

Pakning: 1 stk

Horizontal vægbeslag L510 mm

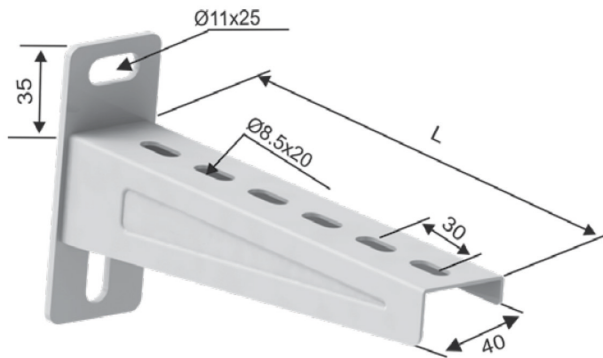

614046 - 614052
Base Hole Detail

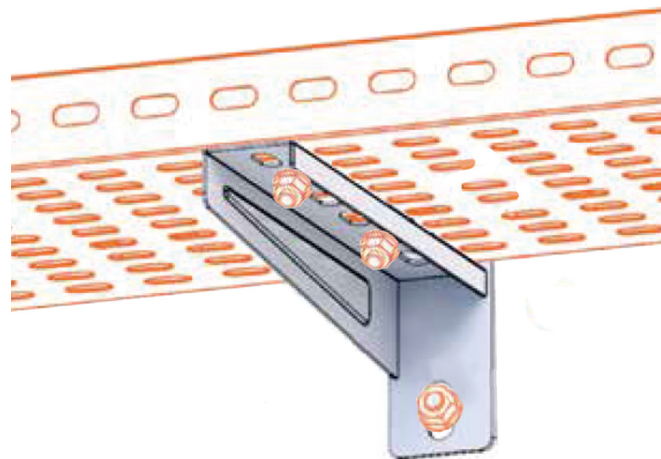
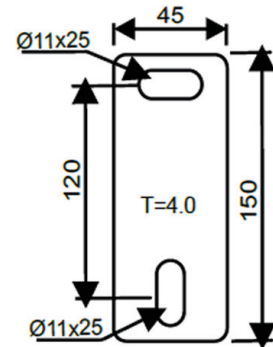

CLASSIFICATION OF ENVIRONMENTS

Corrosion category	Loss of thickness µm/year	Typical environment	
		Outdoor	Indoor
C1 Inconsiderable	>0,1	-	Heated buildings (offices, schools, stores etc.)
C2 Slight	>0,1 until 0,7	Little pollution Like rural areas	Not heated buildings with formation of condensate like store houses, coliseums
C3 Moderate	>0,7 until 2,1	City and industrial environments with moderate pollution	Highly humid production plants like laundry, brewery and diary
C4 Strong	>2,1 until 4,2	Industrial areas and coastlines with moderate salt impact	Chemical plants, swimming pools
C5-I Very strong (industrial)	>4,2 until 8,2	Industrial environment with high humidity and aggressive atmosphere	Buildings or areas with almost permanent condensation and pollution
C5-M Very strong (marine)	>4,2 until 8,2	Coastlines and offshore areas with high salt impact	Buildings or areas with almost permanent condensation and pollution