

# LAN-RACK

19" vægskab 27HE h1300xb600xd600mm  
PPD sort LRW



## Anvendelse

19" vægskab for data installationer. Gedigt design med 19" opspænding for og bag. Aftagelige/afslåelige sideplader. Gælder for udluftninger i top og bund. Mulighed for montage af op til 2 stk. ventilatorer Aftagelig dør, som kan højre og venstre vendes.

## Specifikation

**Materiale:** Pulverlakeret stål

**Farve:** Sort

**Dør:** Perforeret pladedør

**Lås:** Eurolock

Mulighed for tilvalg af Ruko

**Ophæng:** Vægbeslag medfølger

**Belastningskapacitet:** 60kg

**Opspænding:** 19" for og bag

**Electrosteel (ledende)**

**Størrelse:** H1300xB600XD600mm

**HE:** 27HE

**Jording:** Forberedt for jord

**Tilbehørs program:** Stort

**Leveres usamlet (flatpack)**

**Tilvalg:** Samling af skab  
(varenr. 240000)

## 19" vægskab 27HE h1300xb600xd600mm PD sort LRW

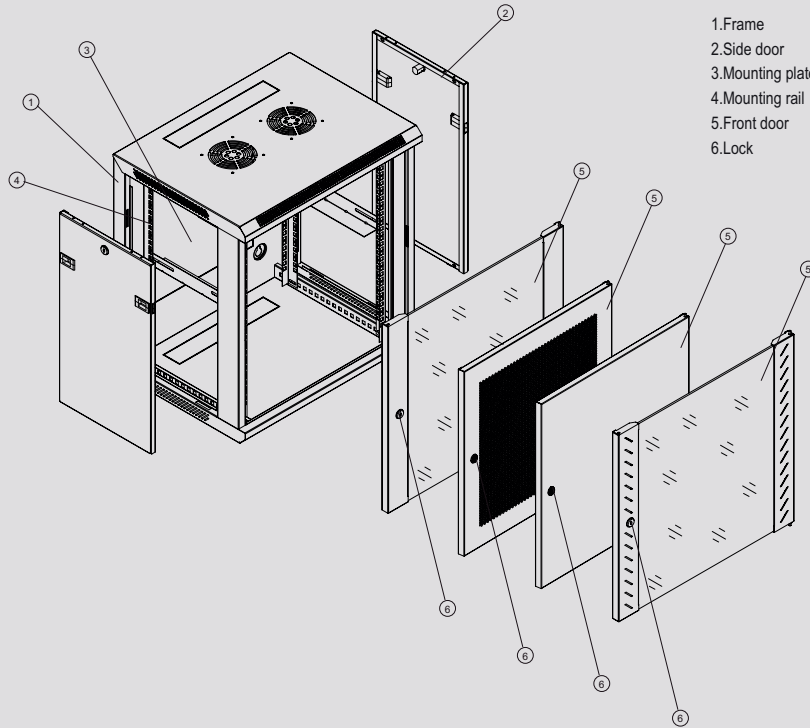

- 1. Frame
- 2. Side door
- 3. Mounting plate
- 4. Mounting rail
- 5. Front door
- 6. Lock

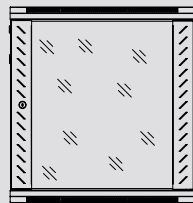

Front

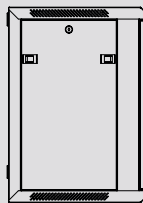

Side

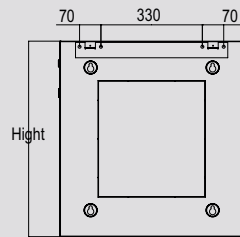

Back

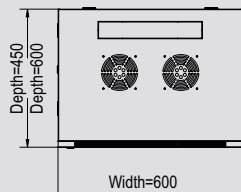

Top

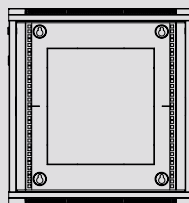

Front (without glass)

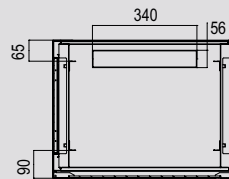

A-A Section

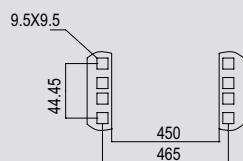

Mounting dimension

## 19" vægskab 27HE h1300xb600xd600mm PD sort LRW

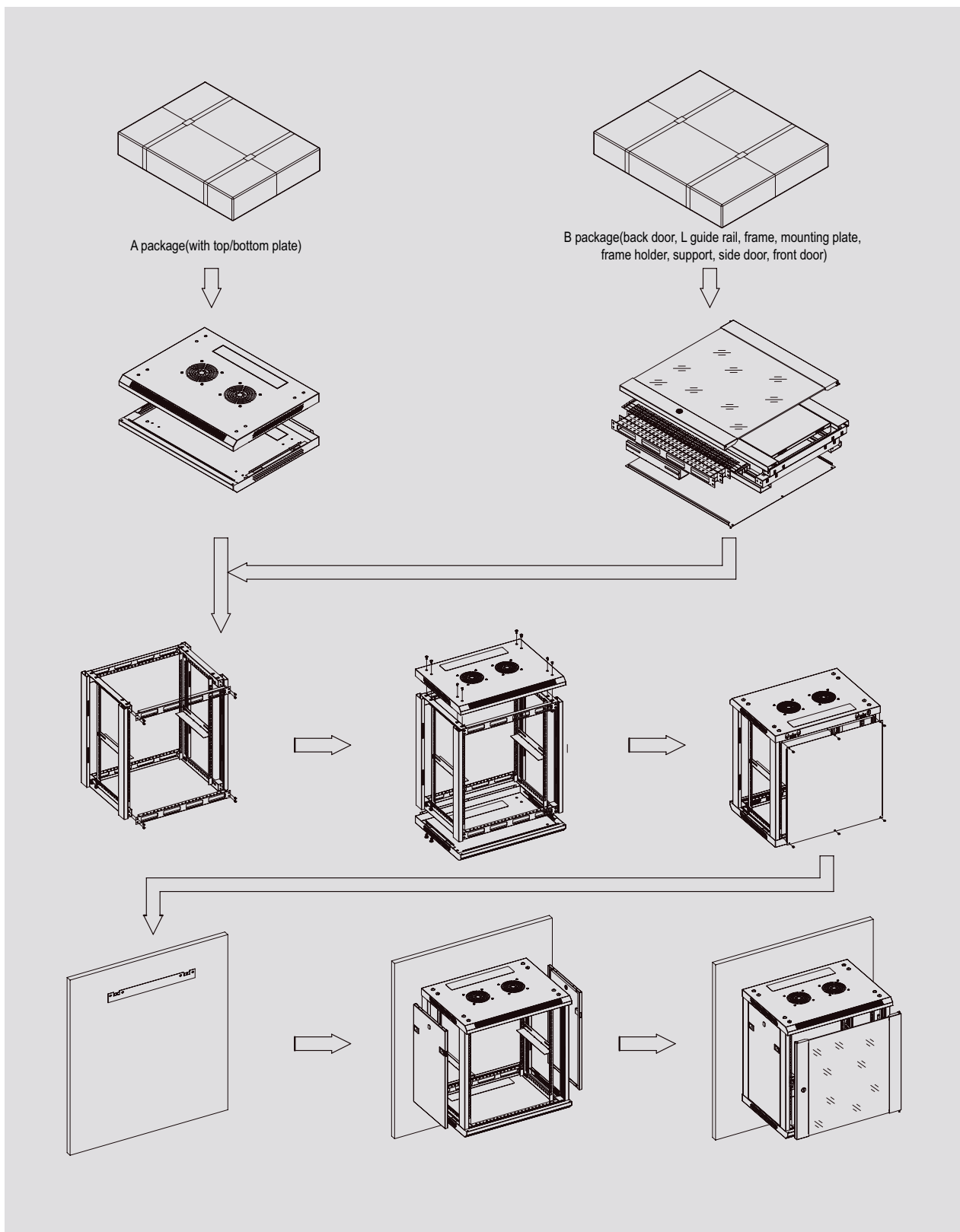

## 19" vægskab 27HE h1300xb600xd600mm PD sort LRW

### Standard

Comply with ANSI/EIA RS-310-D, DIN41491; PART1, IEC297-2, DIN41494; PART7, GB/T3047.2-92 standard. Compatible with metric, ETSI and 19' international standard.

### Features

- Exquisite design with precise dimension and craftsmanship.
- Easily be mounted on wall, or placed on floor after installed castor or feet.
- Loading capacity: 60KG.
- Top and bottom wiring channel could be closed.
- Removable front door and side panel, easily installing and maintaining
- Surface finish: Degreased, acid cleaned, phosphoric, water cleaned, electro-static powder coating, meet ROHS standard.
- Optional color: black/gray
- Optional accessories.

### Materials

Cool rolled steel  
Thickness: Vertical rail:1.5mm

### Application

Widely used in network system, educational system, broadcasting system and telecommunication system. Suitable for placing server computer and precision elec-tronic equipments.