

LAN-RACK

19" vægskab 10HE h553xb600xd600mm
PPD sort LRW



Anvendelse

19" vægskab for data installationer. Gedigt design med 19" opspænding for og bag. Aftagelige/afslåelige sideplader. Gælder for udluftninger i top og bund. Mulighed for montage af op til 2 stk. ventilatorer Aftagelig dør, som kan højre og venstre vendes.

Specifikation

Materiale: Pulverlakeret stål

Farve: Sort

Dør: Perforeret pladedør

Lås: Eurolock

Mulighed for tilvalg af Ruko

Ophæng: Vægbeslag medfølger

Belastningskapacitet: 60kg

Opspænding: 19" for og bag

Electrosteel (ledende)

Størrelse: H553xB600XD600mm

HE: 10HE

Jording: Forberedt for jord

Tilbehørs program: Stort

Leveres usamlet (flatpack)

Tilvalg: Samling af skab
(varenr. 240000)

19" vægskab 10HE h553xb600xd600mm PPD sort LRW

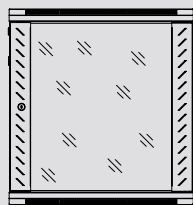
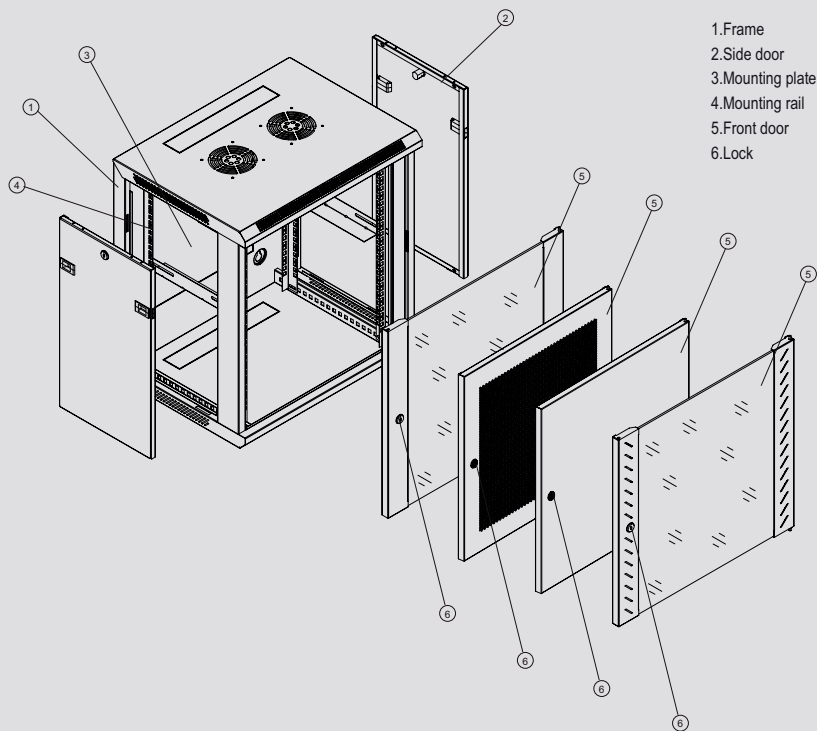

Front

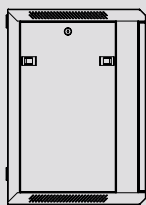

Side

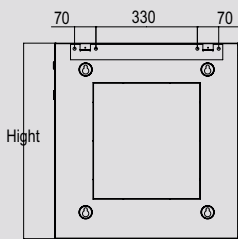

Back

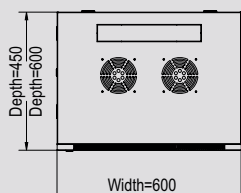

Top

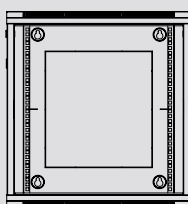

Front (without glass)

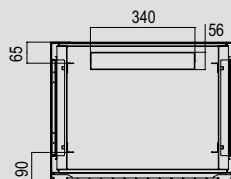

A-A Section

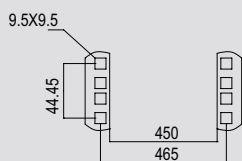

Mounting dimension

19" vægskab 10HE h553xb600xd600mm PPD sort LRW

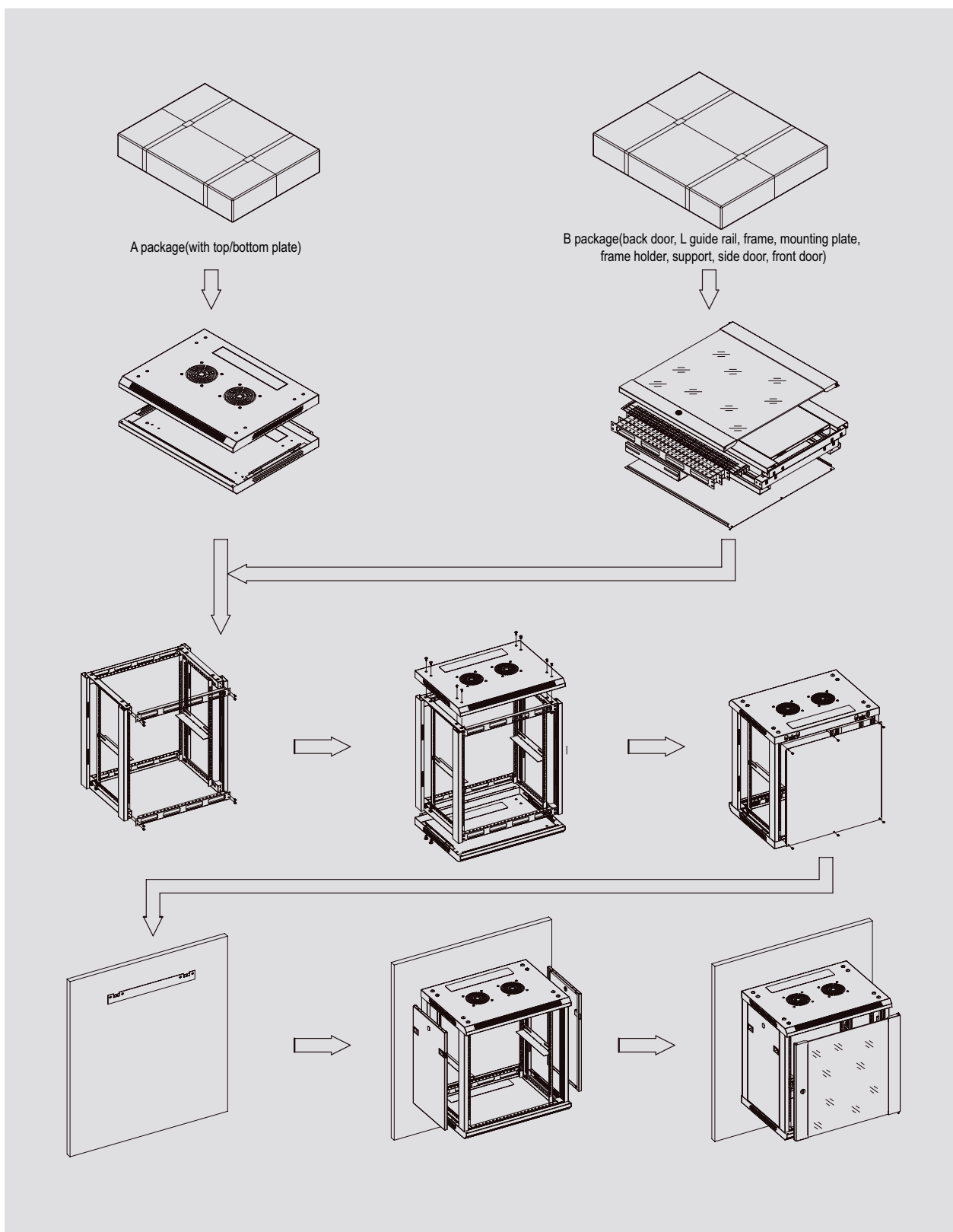

19" vægskab 10HE h553xb600xd600mm PPD sort LRW

Standard

Comply with ANSI/EIA RS-310-D, DIN41491; PART1, IEC297-2, DIN41494; PART7, GB/T3047.2-92 standard. Compatible with metric, ETSI and 19' international standard.

Features

- Exquisite design with precise dimension and craftsmanship.
- Easily be mounted on wall, or placed on floor after installed castor or feet.
- Loading capacity: 60KG.
- Top and bottom wiring channel could be closed.
- Removable front door and side panel, easily installing and maintaining
- Surface finish: Degreased, acid cleaned, phosphoric, water cleaned, electro-static powder coating, meet ROHS standard.
- Optional color: black/gray
- Optional accessories.

Materials

Cool rolled steel
Thickness: Vertical rail:1.5mm

Application

Widely used in network system, educational system, broadcasting system and telecommunication system. Suitable for placing server computer and precision elec-tronic equipments.